



WHAT'S COOKING?

MUURIKKA™

2022



Muurikka for unfor- gettable moments

We at Muurikka have been working for outdoor cooking for decades. Muurikka products gather people together to enjoy cooking and eating good food. We keep searching for new ways of creating unforgettable moments.

Muurikka gives the perfect opportunity to come together around the fire, cook good food, and just enjoy the outdoors and each others company!

We are still continuing these great Finnish traditions with our wide selection of products designed and developed for leisure and outdoor use. With sustainable processes, we manufacture functional, high-quality products that make outdoor cooking a pleasure.

In this brochure you will find many new products and inspiration for outdoor cooking – throughout the year. Welcome to the world of Muurikka!





MUURIKKA

Table of Contents

MUURIKKA

NEW PRODUCTS	6
SMOKING	8
SUMMER KITCHENS	12
MUURIKKA RECIPES	16
ELECTRIC GRILLS	18
MUURIKKA SETS AND GAS BURNERS	20
FIREPITS	24
MUURIKKA PANS	26
OUTDOOR AND PICNIC	30
ACCESSORIES	34

TUNDRA GRILLS®

TUNDRA GRILLS	40
ACCESSORIES AND SPARE PARTS	49
CHIMNEY SETS	54



Our New
Product Range

MUURIKKA PREMIUM SUMMER KITCHEN YOUR CUSTOMISABLE OUTDOOR KITCHEN



Build the summer kitchen of your dreams with the Muurikka Premium Summer Kitchen concept. Create an outdoor kitchen for a wide variety of activities, whether you are using a small or large space. The modules have strong structures and a stylish finish that is sure to please.

COMBINE MODULES AS NEEDED

By combining modules of two different sizes (width 1000 mm and 500 mm), you can build a set that best suits your needs and allows you to cook with different heat sources.

ADD HEAT SOURCES

Choose a heat source for your outdoor kitchen. Depending on the number of modules, you may have multiple heat sources. The module sets can be combined with all Muurikka Pans and other accessories.

PLENTY OF STORAGE SPACE

The Summer Kitchen Table and Cabinet add more storage space to the yard or terrace, so you can keep all your equipment and utensils organised, where you need them the most, for the next meal. Summer Kitchen cabinet conveniently stores, for example, a gas cylinder, trash can, Muurikka pans or even the Muurikka Electric Smoking Oven.

MUURIKKA PREMIUM SUMMER KITCHEN FEATURES

STYLISH DETAILS

The modules are easy to use and have a modern look down to the last detail. The doors and surfaces made from ecological heat-treated pine are high-quality Finnish products.

COMPLETE WITH ACCESSORIES

You can complete the modules with accessories. Wheels make your Summer Kitchen easy to move. Steel side tables give you convenient extra space.

CHOOSE METAL OR WOODEN DOORS

You can outfit your modules with either simple and beautiful black metal doors or sleek wooden doors made from heat-treated pine. The Premium Summer Kitchen table is also available without doors.

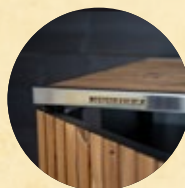

MUURIKKA PREMIUM SUMMER KITCHEN TABLE

54110300



MUURIKKA PREMIUM SUMMER KITCHEN TABLE WITH WOODEN DOORS

54110450



MUURIKKA PREMIUM SUMMER KITCHEN TABLE WITH METAL DOORS

54110460



ACCESSORIES



54110350

MUURIKKA PREMIUM SUMMER KITCHEN SIDEBOARD

The side table offers additional space for cooking. Includes 4 hooks that can be used to hang Muurikka lids, spatulas, tongs, etc. Dimensions 30,5 x 57,5 x 2,5 cm.



54110390

WHEELS FOR SUMMER KITCHEN PREMIUM, 4 PCS

The wheels make Muurikka Premium Summer Kitchen cabinets and tables easy to move. The package contains 4 wheels, 2 of them with a locking mechanism.



MUURIKKA PREMIUM SUMMER KITCHEN CABINET WITH METAL DOOR

54110310



MUURIKKA PREMIUM SUMMER KITCHEN CABINET WITH WOODEN DOOR

54110410

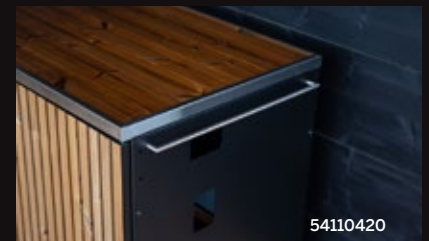

54110420

RAIL HANGER FOR SUMMER KITCHEN PREMIUM

The rail hanger is compatible with Muurikka Premium Summer Kitchen cabinets and tables. Includes 4 S-hooks that can be used to hang Muurikka lids, spatulas, tongs, etc.



MUURIKKA PREMIUM SUMMER KITCHEN METAL DOOR

54110330



MUURIKKA PREMIUM SUMMER KITCHEN WOODEN DOOR

54110320



54110440

HEAT PROTECTION PLATE FOR PREMIUM SUMMER KITCHEN

If you install a Summer Kitchen Table or Cabinet against a flammable wall, you will need a separate heat protection plate when using a gas burner.



SMOKING

In our wide selection of Muurikka smoking ovens and smoking equipment, you will find all you need for a successful smoking experience. Whether you use open fire or electricity, a smoky flavour will make starters, main courses and desserts rich and delicious.





Designed and made in Finland



DESIGN FROM FINLAND



Thermometer

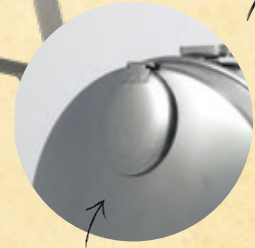

Air Flow Regulator

Muurikka Electric Smoking Oven PRO 1200 W 54420020

MUURIKKA ELECTRIC SMOKING OVEN PRO

PRO is a new and even more versatile version of the original and genuine Muurikka Electric Smoking Oven. Smoke fish, meat, vegetables, game, shellfish...

Smoking adds a fascinating extra flavour to pork tenderloin, breast fillets of turkey and chicken, lamb and mutton as well as all game meat. Thanks to the temperature regulation feature of the Muurikka Electric Smoking Oven PRO, it is now possible to cook delicate foods in the smoking oven preserving the richness of the ingredients. With the thermometer, you watch the smoking temperature, and extra smoke and moisture go out through the ventilation valve in the oven.

TEMPERATURE REGULATION

- With the stepless temperature regulation it is easy to adjust the oven temperature for different kinds of food.

VENTILATION VALVE

- Surplus moisture goes out of the oven through the ventilation valve.

THERMOMETER

- With the thermometer on the oven you can watch the temperature in the oven while using it.

Position 1 = 75–110 °C
 Position 2 = 150–185 °C
 Position 3 = 190–230 °C

Muurikka Electric Smoking Oven PRO 1100 W 54420010



MUURIKKA ELECTRIC SMOKING OVEN PRO 1100 W

Electric Power: 1100 W
 Material: stainless steel
 Size: Ø25 cm length 50 cm
 Weight: 6,7 kg



Utility Patented

MUURIKKA ELECTRIC SMOKING OVEN PRO 1200 W

Electric Power: 1200 W
 Material: stainless steel
 Size: Ø28 cm length 55 cm
 Weight: 7,2 kg

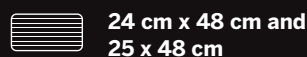

Utility Patented

MUURIKKA

ORIGINAL ELECTRIC SMOKING OVEN

Since 1999 the Original Muurikka Electric Smoking Oven has been recognizable by the stamp "Genuine Muurikka Product". With smoking chips, the high-quality Muurikka Electric Smoking Oven works as a ready-to-use smoking oven, and without smoking chips, it is a versatile grill and outdoor oven throughout the year. You can prepare fish, meat, sausages and vegetables in no time, with or without smoke. One package contains smoking instructions, a small bag of smoking chips, a recipe booklet, removeable handle and a cover to protect your smoking oven against dirt and moisture.



Designed and made in Finland



ELECTRIC SMOKING OVEN 1100 W

Electric Power: 1100 W
Material: stainless steel
Size: Ø25 cm, length 50 cm
Weight: 5,6 kg



24 cm x 42 cm

Original Muurikka Electric Smoking Oven 1100 W 54410020

ELECTRIC SMOKING OVEN 1200 W

Electric Power: 1200 W
Material: stainless steel
Size: Ø28 cm, length 55 cm
Weight: 6,7 kg



24 cm x 48 cm and 25 x 48 cm

Original Muurikka Electric Smoking Oven 1200 W 54410040

MUURIKKA

NOKKELA ELECTRIC GRILL & SMOKING OVEN

Muurikka Nokkela Electric Grill and Smoking Oven is suitable for versatile outdoor cooking, grilling and smoking, both in summer and in winter. It is easy, fast and tidy. You can use Muurikka Nokkela both as a grill and as a smoking oven, and can conjure up delicious smoked and grilled foods, e.g. fish, meat, seafood, and vegetables. When the resistor is fastened to the lower part, you can use Muurikka Nokkela as a smoking oven. When the resistor is fastened to the upper part, it is above grilled food, and Muurikka Nokkela can now be used as a smokeless grill.



MUURIKKA

NOKKELA ELECTRIC GRILL AND SMOKING OVEN 900 W

Electric Power: 900 W
Material: stainless steel
Size: 45,5 cm x 30 x 37,5 cm
Weight: 3,5 kg



34 x 22 cm

Muurikka Electric Grill & Smoking Oven 900 W 54430010

Utility Patented

MUURIKKA

NOKKELA ELECTRIC GRILL AND SMOKING OVEN 1200 W

Electric Power: 1200 W
Material: stainless steel
Size: 59 cm x 37,5 x 44 cm
Weight: 6,2 kg



43 x 25 cm

Muurikka Electric Grill & Smoking Oven 1200 W 54430020

Utility Patented



MUURIKKA

OUTDOOR SMOKER FOR CAMPFIRE AND GAS GRILL

The Muurikka Outdoor Smoker can be used over a campfire or in a gas or charcoal grill with a suitable bbq rack. Includes wire legs for using over open fire.
Size: 16 cm x 40 cm • Weight: 2,1 kg



14 x 38 cm

Muurikka Outdoor Smoker for campfire and gas grill 54920610



MUURIKKA ELECTRIC SMOKINGOVEN BASIC 1100W

A Genuine and Original Muurikka Electric Smoking Oven now as a self-assembled version. Basic Electric Smoking Oven has all the same quality features as other Original Muurikka Smokers.

Electric Power:

1100 W

Cord: 2 m, an earthed plug 230v 1100w 50Hz

Material:

stainless steel

Size: Ø25 cm

Length: 50 cm



Muurikka Electric Smoking Oven BASIC 1100W 54410060

MUURIKKA GRILL POCKET NONSTICK

Muurikka A non-stick grill pocket is an excellent and convenient aid for smoking and grilling. The prepared food stays nicely inside the pocket and can be served easily by pouring the food out of the pocket.

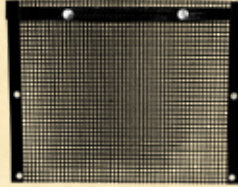

Muurikka Grill Pocket nonstick 54920830



MUURIKKA PROTECTIVE DRIP TRAY FOR ELECTRIC SMOKING OVEN

Made out of stainless steel, the drip tray is used with Muurikka Electric Smoking Ovens. The tray helps protect the environment from dripping grease and allows the smoker gratings to be soaked in the tray after use.



Muurikka Protective drip tray for Electric Smoking Oven 54460170



PROTECTIVE COVER OF ELECTRIC SMOKING OVENS

Easy to put on the Muurikka Smoking Oven. Protects against dirt and moisture; not waterproof.

Cover for Original 1100W, Nokkela 900W 54460080

Cover for Original 1200W, PRO 1200W & 1100W, Nokkela 1200W 54460100



SMOKING CHIPS

Brandy/Whisky/Cognac smoking chips are ideal for charcoal and gas barbecues, electric smoking ovens and other smoking ovens. **Weight:** 550g

Muurikka Apple Smoking Chips 54460010
 Muurikka Cherry Smoking Chips 54460020
 Muurikka Beech Smoking Chips 54460040
 Muurikka Oak Smoking Chips 54460030



SMOKING CHUNKS

Muurikka Smoking Chips give colour and a slightly sweet aroma to smoked food.

Weight: 360g

Muurikka Whiskey Smoking Chunks 54460050
 Muurikka Cognac Smoking Chunks 54460060
 Muurikka Brandy Smoking Chunks 54460070



1. Muurikka Smoking Container

Round shaped Smoking Container is ideal for Muurikka Summer Kitchen Gas and Electric, which both provide constant and easily regulated temperature for smoking of food. Suitable also for open fire.



Ø 40 CM

Muurikka Smoking Container Ø 42 cm 54440010



Ø 31CM

Muurikka Smoking Container Ø 32 cm 54440030

2. Muurikka Smoking Box

Can be used in many ways: over open fire, and on a gas or charcoal grill. Smoking Box has two griddles and one fat plate.

Muurikka Smoking Box 54440020



23 x 39 cm 2 pcs



3. Muurikka Smoking Chips of Alder

2 L/330g and 10 L/1650g

Muurikka Smoking Chips of Alder 2 L 54460120
 Muurikka Smoking Chips of Alder 10 L 54460110

4. Muurikka Grill and Smoking Basket

With the Basket you can grill even small bits of food easily without a risk of food falling down from the griddle. The Basket has a non-stick surface which makes it easier to grill e.g. fish or chicken with skin. The Basket is easy to keep clean, and it can be washed in a dishwasher.

Muurikka Grill and Smoking Basket 20 x 30 cm 54920080

Muurikka Grill and Smoking basket with reinforced edges 22 x 40 cm 54920860

SUMMER KITCHENS

For your Muurikka Summer Kitchen, we have a wide variety of accessories so that you can customise the Summer Kitchen to best fits your needs. You can smoke, boil, grill or prepare a paella or a wok for a bunch of people! The wheels make it easy to move the cart, and the side tables provide extra space for cooking utensils. The side tables can be folded down to make the cart fit into a small space. The cart also has plenty of storage space for various accessories and equipment, e.g. pans or a smoking container.





Summer Kitchen GAS black
54110100
Summer Kitchen GAS grey
54110110

MUURIKKA SUMMER KITCHEN GAS

Dimensions: 135 x 67 x 93 cm

Versatile Muurikka Summer Kitchen GAS is suitable for everyday cooking. In the deep Muurikka Paella Pan, you can easily make dishes of meat, fish and vegetables – and, of course, Muurikka pancakes for dessert! Keep the Paella Pan in the handy protective bag. On top of the Gas Burner, you can use different Muurikka pans, grills, griddles, wok pans and a smoking container.

- Gas Burner D-350 (7,9 kW) with two gas rings, new stylish wind-shield in black and short legs.
- Summer Kitchen Cart made of black painted steel has foldable side tables of black/grey painted pinewood
- Muurikka Paella Pan, cast iron with a cover bag
- Protective Cover for Summer Kitchen



2 🔥  7,9 kW  45 cm  

**CUSTOMISE YOUR SUMMER
KITCHEN WITH COMPATIBLE
MUURIKKA PRODUCTS!**

More information on page 17





Summer Kitchen Gas Maxi black 54110120



Summer Kitchen Gas Maxi grey 54110130

SUMMER KITCHEN GAS MAXI

Dimensions: 135 x 74 x 90 cm

Versatile Muurikka Summer Kitchen GAS MAXI is suitable for everyday cooking even for bigger bunch of people with large Muurikka Griddle Pan. In the versatile, original and genuine Muurikka Griddle Pan, you can easily make dishes of meat, fish and vegetables – and, of course, Muurikka pancakes for dessert! Keep the Muurikka Griddle Pan in the handy protective bag. On top of the Gas Burner, you can use different Muurikka pans, grills, griddles, wok pans and a smoking container.

2 🔥 🍳 7,9 kW (●) 58 CM ● ●

- Gas Burner D-350 (7,9 kW) with two gas rings, new stylish windshield in black and short legs.
- Summer Kitchen Cart made of black painted steel has foldable side tables of black/grey painted pinewood
- The original and genuine 58 cm Muurikka Griddle Pan in its protective bag and Muurikka Lid

MUURIKKA SUMMER KITCHEN CART

Dimensions: 135 x 47 x 78 cm

Muurikka Summer Kitchen MAXI Carts have black steel frame and lots of storage space for accessories and supplies. Wooden side tables are foldable and available in various colours.



Summer Kitchen Cart MAXI black, 54110090
 Summer Kitchen Cart MAXI grey, 54110080
 Summer Kitchen Cart, heat-treated pine, 54110150
 Summer Kitchen Cart wooden parts, heat-treated pine, 54110140





Summer Kitchen ELECTRIC black 54210020



Summer Kitchen ELECTRIC grey 54210010

SUMMER KITCHEN ELECTRIC

Dimensions: 135 x 52 x 92 cm

The Summer Kitchen ELECTRIC is always ready and exceptionally easy to use. The heat source, the Muurikka Electric Grill, instantly reaches a uniform temperature. With its accurate heat regulation, the grill is ideal for cooking many kinds of dishes either directly on the grill grid or with different Muurikka Pans, Steel Woks and Smoking Container. With Muurikka Griddle Pan you can cook all delicacies: starters, main courses and desserts. On top of the Gas Burner, you can keep different Muurikka pans, grills, griddles, wok pans and a smoking container.

⚡ 2200W 🌐 Ø 40 CM 🍳 48 CM ● ●

- The powerful Electric Grill 2200W with a Lid heats up quickly and evenly and has an easy temperature regulation.
- Summer Kitchen Cart made of black painted steel has foldable side tables of black/grey painted pinewood
- The original and genuine 48 cm Muurikka Griddle Pan in its protective bag

↙ Heat treated pine wooden parts are also sold separately



NEW!

MUURIKKA PROTECTIVE COVER FOR SUMMER KITCHEN

Elegant and durable Protective Cover protects Summer Kitchen and Carts from dust and moisture. The lower edge of the Cover has a foldable extension with velcro-type strap closing for using the Cover on top of Summer Kitchen Electric or Gas.

Muurikka Protective Cover for Summer Kitchen 54910120





**Recette à la
Henri Alén**



*The recipe
yields the best results
when cooking with
the Muurikka Electric
Smoking Oven
PRO*

FRESH CHEESE WITH SMOKED VEGETABLES

- Cut up the sweet peppers and the courgette into chunks.
- Cut the broccolini in half.
- Put the vegetables in a bowl and add the cherry tomatoes, thyme and olive oil. Also add a little salt and black pepper.
- Roll the vegetables carefully in oil and place in the smoking basket.
- Start smoking at level 3 until smoke begins to properly form. Then drop the power to level 2 and smoke the vegetables for around 30 minutes.
- Finally, sprinkle with plenty of chopped fresh cheese and basil.

**FIND MORE RECIPES
MUURIKKA.COM**

Ingredients

- 400 g fresh cheese
- 2 sweet peppers
- 1 courgette
- 1 box of cherry tomatoes
- 200 g broccolini (baby broccoli with stems)
- 4 sprigs of thyme
- a little olive oil
- salt and black pepper
- 1 pot of chopped basil

Additionally: Muurikka smoking basket

MUURIKKA™

Summer Kitchen

Customise your Muurikka Summer Kitchen with compatible Muurikka Products.

Summer Kitchen Casserole	 15 l	 15 l	×
Grilster	×	×	 42 cm
Smoking Container	 32 cm • 42 cm	 32 cm • 42 cm	 32 cm • 42 cm
Paella Pan Steel	 40 cm • 50 cm	 40 cm • 50 cm	 50 cm
Muurikka Carbon Steel Paella Pan	 45 cm	 45 cm	 45 cm
Wok Pan Steel	 40 cm • 50 cm • 60 cm	 40 cm • 50 cm • 60 cm	 50 cm
Muurikka Wok Pan	 42 cm	 42 cm	×
Muurikka Grill Pan	 42 cm	 42 cm	 42 cm
Muurikka Griddle Pans	 38 cm • 48 cm • 58 cm	 38 cm • 48 cm • 58 cm	 48 cm • 58 cm
Muurikka Multifunctional Pan	 41,5 cm	 41,5 cm	 41,5 cm
Muurikka Paella Pan	 45 cm	 45 cm	 45 cm
Pan with Sections	 43 cm	 43 cm	 43 cm
Summer Kitchens			

SUMMER KITCHEN GAS

SUMMER KITCHEN GAS MAXI

SUMMER KITCHEN ELECTRIC



ELECTRIC GRILLS

Very efficient Muurikka Electric Grill even for heavy grill users – it heats up quickly, and with stepless power regulation, it is ideal for many kinds of grilling and cooking. The grill is very easy to keep clean – under the grill grid there is a drip tray preventing pieces of food and fat dripping onto the bottom of grill. The grill is compatible with different Muurikka Pans, Steel Woks, Grillster and Smoking Container.



Pleasure with Grilling

-in the garden, terrace and balcony

Very efficient

Electric Grill reaches a uniform temperature instantly. Accurately adjustable – suitable for all foods to be grilled and cooked.

Ready to Grill in
3min

Easy to maintain

Drip tray of aluminium under the grill grid helps to keep grill clean.

Compatible products

On top of the grill you can use compatible Muurikka products.



1. Drip Tray for Muurikka Electric Grill 54920350



Muurikka Classic Electric grill 54220020



MUURIKKA CLASSIC ELECTRIC GRILL 2200W

Dimensions: 100 x 52 x 83 cm

With the easily moved Muurikka Classic Electric Grill, you can cook all delicacies from vegetables to beautiful brown grilled steaks. Very efficient electric grill is suitable for any grill users – it heats up instantly and with its stepless power regulation it can be used for many kinds of grilling and cooking. The compact, solid grill fits into small spaces, e.g. in the balcony, the side tables are detachable. The mid shelf can be used for storing e.g. spices. Ready to use in three minutes!

- Efficient Electric Grill with 2200 W power, heats up quickly and constantly, easily adjustable temperature
- The cart is made of black painted steel. Black painted wooden side tables.

⚡ 2200W ⚙️ Ø 40 CM

MUURIKKA ELECTRIC GRILL

This multifunctional Electric Grill is a versatile grill for outdoor cooking. Muurikka Electric Grill has a lid of stainless steel, one griddle, and a drip tray of aluminium foil.

Material: stainless steel • Electric Power: 2200 W
Size: Ø 42 cm • Weight: 6,7 kg

⚡ 2200W
⚙️ Ø 40 CM

Muurikka Electric Grill 54220010



MUURIKKA GRILSTER

With Muurikka Grilster steaks, chickens, fish, sausages or toasts are easy to grill on both sides, as when turning with grilster there is no risk of food falling down. Grilster can be used on all kind of grills and over an open fire. When opened, Grilster can be used as an ordinary griddle.
Size: Ø 40 cm.



Muurikka Grilster 54920250

1. DRIP TRAY FOR MUURIKKA ELECTRIC GRILL 5 pcs.

Tray prevents food and fat dripping and cooking onto the bottom of the grill. It also helps to keep grill clean.

Package: 5 pcs.



MUURIKKA **SETS AND** **GAS BURNERS**

A Muurikka Set provides you with all you need for successful outdoor cooking. You can add various accessories to a set. The efficient gas burners heat up quickly and the power is easy to adjust. The windshield keeps the flame from going out too easily.



Muurikka Sets

A high-quality Muurikka Set provides you with all you need for successful outdoor cooking. The sets include a pan, a gas burner with long legs as well as Silava Frying Fat for seasoning the pan before the first use.

Muurikka PRO Steel 58 Set

Muurikka PRO Steel 58 set has stylish windshield made of stainless steel. The Muurikka Set includes Muurikka Pan 58 cm in protective bag, D-400 gas burner with two gas rings and regulators, protective cover and Muurikka Silava Frying Fat.



Muurikka PRO Steel 58 Set 54120210

Muurikka Paella Set

Set includes original Muurikka Paella Pan 45 cm in cover bag, gas burner D-350, two gas rings, new integrated windshield in black, long legs and Muurikka Silava Frying Fat.



Muurikka Paellaset 5412018H

2 🔥 🔥 11,4 kW 58 CM 2 🔥 🔥 7,9 kW 45 CM



Muurikka Set 48

Set includes original Muurikka Griddle Pan 48 cm in cover bag, gas burner D-350, two gas rings, new integrated windshield in black, long legs and Muurikka Silava Frying Fat.

Muurikka Set 48 5412014H

2 🔥 🔥 7,9 kW 48 CM



Muurikka Set 58

Set includes original Muurikka Griddle Pan 58 cm in cover bag, gas burner D-400, two gas rings, new integrated windshield in black, long legs and Muurikka Silava Frying Fat.

Muurikka Set 58 5412015H

2 🔥 🔥 11,4 kW 58 CM



Muurikka Set 78

Set includes original Muurikka Griddle Pan 78 cm, gas burner D-500, two gas rings, new integrated windshield in black, long legs, protective cover and Muurikka Silava Frying Fat.

Muurikka Set 78 5412017H

2 🔥 🔥 14,1 kW 78 CM

PROTECTIVE COVER FOR MUURIKKA SETS

Protects the whole Set, both Pan and Gas Burner, against dirt and moisture; not waterproof.

Muurikka Cover for Set 48, 58, Paella
Muurikka Cover for Set 78



Cover for Set 48, 58, Paella 54910050
Cover for Set 78 54910070

Muurikka 100 and 120



MUURIKKA 100 AND 120 ORIGINAL

Muurikka 100 and 120 Original Pans are ideal for a large bunch of people, but also suitable for a family. A versatile pan for almost any kind of outdoor cooking! A fixed windshield of steel and threaded pipe legs. The handles make lifting easy.

🔗 95 CM 🔗 118 CM

Muurikka 100 Original 54010100
Muurikka 120 Original 54010120

SIDE TABLES FOR MUURIKKA 100 / 120

The high-quality side tables provide you with additional space for cooking. The wooden side tables are made of Finnish ecological heat-treated pinewood. Size 37 x 75 cm.

Side Tables for Muurikka 100/120 (2 pcs)
54920640



MUURIKKA SET 100

Muurikka 100 Original is a perfect for outdoor cooking at large events and festivals, but ideal also for professional use at restaurants and in catering. You can cook any kind of food, like e.g. meat, fish, vegetables, paella, and of course Muurikka Pancakes.

Muurikka 100 Original Set has Muurikka Pan, fixed windshield of steel, three strong threaded legs, D-600 gas burner with three gas rings, two side tables and a protective cover.

🔥 🔗 21 kW 🔗 95 CM

Muurikka 100 set 54120110

MUURIKKA SET 120

The largest in the set, this Muurikka 120 Original Pan is ideal for a large bunch of people, but also suitable for a family. A versatile set for almost any kind of outdoor cooking!

Muurikka 120 Original Set has Muurikka Pan, fixed windshield of steel and threaded legs, D-600 gas burner with three gas rings, two side tables and a protective cover.

🔥 🔗 21 kW 🔗 118 CM

Muurikka 120 set 54120130



MUURIKKA PROTECTIVE COVER FOR 100/120

Protects against dirt and moisture; not waterproof.

Muurikka Protective Cover for 100 54910080
Muurikka Protective Cover for 120 54910090

Gas Burners

MUURIKKA PRO STEEL GAS BURNER D-400 WITH SHORT LEGS

Muurikka PRO Steel D-400 gas burner has stylish windshield made of stainless steel. The gas burner has two separate regulators and gas rings that can be used separately or together; for example, if you want to put a smaller pan on the burner, you can use the inner ring alone.



Material: enamelled steel
Outer gas ring: Ø 40 cm
Inner gas ring: Ø 21 cm
Height: 29 cm
 Muurikka PRO Steel Gas Burner D-400 with short legs 54120230

GAS BURNER D-350

The compact gas burner D-350 with two gas rings and two power regulators is ideal for heating small and medium-sized pans.

2 🔥 7,9kW

Material: enamelled steel
Size: Ø 35 cm
Height with short legs: 29 cm
Height with long legs: 85 cm

Gas Burner D-350, with short legs 54130130
 Gas Burner D-350, with long legs 54130100



GAS BURNER D-400

Gas Burner D-400 with two gas rings and two power regulators. Can be used with larger or smaller pans and either with the smaller gas ring or both together, depending on the pan size.

2 🔥 11,4kW

Material: enamelled steel
Outer gas ring: Ø 40 cm
Inner gas ring: Ø 21 cm
Height with short legs: 29 cm
Height with long legs: 85 cm

Gas Burner D-400 with short legs 54130140
 Gas Burner D-400 with long legs 54130110

GAS BURNER D-600

The D-600 gas burner with its three gas rings and three power regulators can be used with one or more gas rings according to the size of the pan. With its large diameter, it is suitable for heating large pans.

3 🔥 21kW

Material: enamelled steel
Outer gas ring: Ø 60 cm
Middle gas ring: Ø 40 cm
Inner gas ring: Ø 30 cm

Gas Burner D-600 54130070



GAS BURNER D-500

Gas Burner D-500 with two gas rings and two power regulators. Can be used with larger or smaller pans and either with the smaller gas ring or both together, depending on the pan size. The diameter is sufficient even for heating larger pans.

2 🔥 14,1kW

Material: enamelled steel
Outer gas ring: Ø 50 cm
Inner gas ring: Ø 30 cm
Height with short legs: 29 cm
Height with long legs: 85 cm

Gas Burner D-500 54130080
 Gas Burner D-500 with short legs 54130150
 Gas Burner D-450 with long legs 54130120





MUURIKKA **FIREPIT**

Muurikka Firepits are made of 3 mm thick Finnish steel and manufactured in Finland. These robust, multigenerational Firepits have been made to endure the extreme weather conditions of the North and high temperatures. The Firepit is supported by three sturdy and detachable legs. The Firepit is ready for use and easy to move around thanks to the side handles. Open fire creates a pleasant atmosphere and warmth in your garden or cottage. Gather around the round Firepit with your family and friends and enjoy the charming atmosphere and open fire cooking together. Heat up the Firepit with charcoal or wood.

**Various accessories available for cooking.
Learn more at muurikka.com**

**MUURIKKA
FIREPIT 60**

Height: 31 cm **Diameter:** 61 cm
Material: steel **Weight:** 10 kg
Muurikka Firepit 60 54810010



MUURIKKA FIREPIT 70

Height: 31 cm **Diameter:** 72 cm
Material: steel **Weight:** 14,5 kg
Muurikka Firepit 70 54810030

**MUURIKKA
FIREPIT 60 COR-TEN®**

Height: 31 cm **Diameter:** 61 cm
Material: steel **Weight:** 11 kg
Muurikka Firepit 60 COR-TEN® 54810020

**MUURIKKA FIREPIT 70
COR-TEN®**

Height: 31 cm **Diameter:** 72 cm
Material: steel **Weight:** 14,5 kg
Muurikka Firepit 70 COR-TEN® 54810040

Exposure to weather conditions gives the COR-TEN® steel Firepit a beautiful rusty colour in the course of time. A new Muurikka Firepit is grey but it turns slowly into rusty brown thanks to time and weather conditions. Each Firepit has a unique natural surface texture.



**MUURIKKA
SPARK SCREEN**

Diameter: 61 cm

Spark screen with handle. Compatible with Muurikka Firepit 60.

Muurikka Spark Screen
61 cm 54810090

**MUURIKKA
SPARK SCREEN**

Diameter: 71 cm

Spark screen with handle. Compatible with Muurikka Firepit 70.

Muurikka Spark Screen
71 cm 54810100

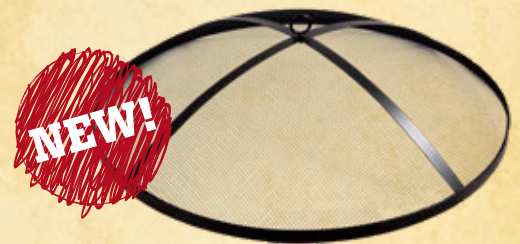

MUURIKKA GRILL GRATING WITH A STAND

Sturdy BBQ steel plate with stand. Compatible with Muurikka Grill Plates and Grill Plate with legs; place the stand over the hole in the grill plate. Suited for all grill plates. The griddle comes with a convenient

handle. The stand can also be used with most Muurikka Pans.

Griddle diameter: 31 cm
handle length: 11,5 cm
Material thickness: 3 mm



Muurikka grill grating with a stand 54810080

**MUURIKKA
GRILL PLATE 60**

Compatible with the Muurikka Firepit 60.

Diameter: 61 cm
Material: steel
54810050

**MUURIKKA
GRILL PLATE 70**

Compatible with the Muurikka Firepit 70.

Diameter: 72 cm
Material: steel
54810060



MUURIKKA PANS

Original Muurikka Griddle Pans are manufactured in Finland since 1976. These versatile frying pans for outdoor cooking can be used over an open fire, on gas burners and on electric, charcoal and briquet grills. With Muurikka Griddle Pans you can cook anything from starters to desserts.





ORIGINAL MUURIKKA GRIDDLE PAN

38 cm 48 cm 58 cm

Material: hot-rolled steel



Muurikka
Griddle Pan 38 cm 54010020
Griddle Pan 48 cm 54010040
Griddle Pan 58 cm 54010060



ORIGINAL MUURIKKA GRIDDLE PAN WITH LEGS

38 cm 48 cm 58 cm 78 cm

With three 22 cm (30 cm) screw-in legs.
Suitable for open fire. Packed in a carton box.

Material: hot-rolled steel

Muurikka
Griddle Pan 38 cm with Legs
54010150
Griddle Pan 48 cm with Legs
54010030
Griddle Pan 58 cm with Legs
54010050
Griddle Pan 78 cm with Legs
54010070

MUURIKKA GRILL PAN

With the Grill Pan you fry or grill food with less fat. This pan keeps a constant temperature and resists rough handling. The reverse side that has no ridges, can be used for frying. Suitable for gas, open fire and for Muurikka Electric Grill.



Size: Ø 42 cm
Material: cast iron
Comes with a protective bag.

Muurikka Grill Pan
54020010

MUURIKKA MULTIFUNCTIONAL PAN

Cast Iron Multifunctional Pan has seven round moulds of Ø 13 cm, and is especially suitable e.g. for pancakes, blinis, burger beefs and buns, frying eggs, cakes, etc. The Pan heats up evenly and remains warm for long time. Withstands even high heat and metal cooking tools. The surface is treated with palm grease. Suitable for open fire.



Size: Ø 41,5 cm, 13 cm
Material: cast iron
Comes with a protective bag.

Muurikka Multifunctional Pan
54020020

MUURIKKA PAELLA PAN

With this Paella Pan you can cook all kinds of food, e.g. paella, and risotto. Cast-iron Paella Pan has an even bottom which ensures very good frying performance. The pan heats up evenly and remains warm for a long time. Withstands even high heat and metal cooking tools. The surface is treated with palm grease. Suitable for open fire.



Size: Ø 45 cm
Material: cast iron
Comes with a protective bag.

Muurikka Paella Pan
54020030

MUURIKKA PAN WITH TWO SECTIONS

Muurikka Pan with two sections is ideal for cooking multiple dishes, as flavors and ingredients do not get mixed. Cook up multiple dishes at the same time and use different spices and seasoning for each dish, or keep fish-, vegetarian- or meat dishes separate in each section.



Size: Ø 43 cm
Material: cast iron
Comes with a protective bag.

Muurikka Pan with two sections
54020040

MUURIKKA SILAVA FRYING FAT WITH RAPESEED OIL 110 g

The Muurikka Silava Frying Fat is ideal for seasoning e.g. new Muurikka pans of hot-rolled steel and of cast iron. This pure natural product of pork fat and rapeseed oil, is easy to use and to dispense directly from the tube. Suitable also for frying food when giving a crisp surface.

Silava Frying Fat with rapeseed oil 54920020



MUURIKKA FRYING SPRAY

250 ml

The Muurikka Frying Spray is ideal for all frying, roasting, and baking, as well as for greasing e.g. cake tins, pans and casseroles. When using frying fat in a spray form, less fat is needed in cooking. This spray is vegan-product made of rapeseed oil and -lecithin.

Muurikka Frying Spray 54920010



**Good care makes
your Muurikka Pan
lifelong!**

HERE'S HOW YOU TAKE CARE OF YOUR MUURIKKA PAN

Good care makes your Muurikka Pan lifelong. Though Muurikka Pans are made of sturdy and durable iron, also they need some care. With the followings instructions you can keep your pans in good condition year after year and they won't become rusty.

Taking a Muurikka Pan into use

Clean the new pan by washing it with mild detergent or hot water, heat the pan dry and make the fat treatment immediately after cleaning as follows: Wipe the pan with oil or spread evenly a thin layer of Muurikka Silava Frying Fat on the surface of the pan.

The fat may not flow onto the bottom of the pan thickly because when fat accumulates, it burns to an uneven mass.

Heat the pan hot with a gas burner, in an electric grill or over glowing embers so that the fat darkens and dries in the pan at least in the middle part of the pan.

You can wash the pan again and make the fat treatment again if necessary. You can repeat the greasing and heating until the pan turns black but this is not necessary; when used the pan still gets darker and more patinated.

Cleaning

Always clean the pan after use. The best way to clean the pan is immediately after use. Put a little water on the pan, boil up and clean the pan with a turner and kitchen paper. Wipe the pan dry and grease the frying side lightly with cooking oil or unsalted Muurikka Silava Frying Fat.

Storage

Clean, dry and grease the pan before a longer storage by heating with Muurikka Silava Frying Fat (heating removes moisture from the pan and Silava prevents rusting). Keep the pan in a dry place.

If your Muurikka-Pan is rusty

If the pan has been exposed to moisture during storage and is rusty, don't worry. Rub the pan with steel wool or grill brush, clean and make the fat treatment according to the instructions on taking a Muurikka Pan into use. This way your pan is again in good condition.

Old trick with salt

When your Muurikka Pan is dirty or you want to clean the pan between dishes of different tastes, table salt is good means. Spread plenty of salt on the Muurikka Pan and keep on low heat for some minutes. Salt absorbs fat, moisture and dirt. After the dirt has been absorbed erase salt e.g. with a turner, put a little water on the pan and wipe the pan clean. Finally, remember to dry and grease the pan well. This way your Muurikka Pan is again as good as new.

MUURIKKA COVER BAG FOR MUURIKKA PANS

Multipurpose and strong cover bag for all Muurikka pans. Protects pans against corrosion. Ideal for storage and carrying of Muurikka Pans and all accessories.

Cover Bag for Muurikka Griddle Pan 48 cm 54910020
Cover Bag for Muurikka Griddle Pan 58 cm 54910030



MUURIKKA LIDS

Versatile Lids for various Muurikka Pans and for other frying pans. Under the lid food is cooked in shorter time, and it keeps food warm longer.

Material: stainless steel

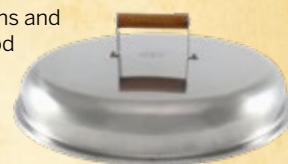

Muurikka Lid 44 cm 54920480 • Muurikka Lid 58 cm 54920490
Muurikka Lid 78 cm 54920500

MUURIKKA WOK-PAN 9L WITH COVER BAG

You can make light wok dishes, and even many soups with this Wok-Pan. Suitable for open fire, gas burners and gas grills, and ideal for Muurikka Summer Kitchen Gas (not Electric).

Material: hot-rolled steel
Size: Ø 43 cm.

Muurikka Wok-Pan 9L
with Cover Bag 54010140



MUURIKKA WOK-PAN 9L WITH COVER BAG

With three 22 cm screw-in legs.

Material:
hot-rolled steel
Size: Ø 43 cm.

Muurikka Wok-Pan 9L
with Legs 54010130



MUURIKKA STEEL PAELLA PAN

40 cm, 50 cm, 60 cm and 70 cm

High-quality Paella Pan, also for open fire. The elegant pan can also be used as a serving dish. Store in a dry place.

Material: cold-rolled steel



Muurikka
Steel Paella Pan 40 cm 54030040
Steel Paella Pan 50 cm 54030050
Steel Paella Pan 60 cm 54030060
Steel Paella Pan 70 cm 54030070

MUURIKKA STEEL WOK

40 cm, 50 cm and 60 cm

You can cook all kinds of wok dishes, and soups. Suitable also for open fire. Store in a dry place.

Material: cold-rolled steel



Muurikka
Steel Wok Pan 40 cm 54030140
Steel Wok Pan 50 cm 54030150
Steel Wok Pan 60 cm 54030160

MUURIKKA CARBON STEEL PAELLA PAN

Made for rough use! For gas, electricity and open fire. **Diameter:** 45 cm • **Material:** Carbon steel.



Muurikka
Carbon Steel Paella Pan
54030170

MUURIKKA PRO CARBON STEEL PAN



Muurikka PRO Carbon Steel Pan is suited for use on a grill, open fire and oven. The pan resists high heat and use. The base structure of the pan ensures that oil spreads more evenly over the pan bottom. With good care and seasoning, the surface of the pan will gain a natural non-stick surface, decreasing the need for care and improving the non-stick properties. Silicone hand guard included. **Diameter:** 30 cm.

54090030

MUURIKKA STEEL WOKS AND PAELLA PANS – FIRST USE AND MAINTENANCE:

Boil up some water in the pan. Then wash the pan with water and detergent. Dry the pan immediately after washing it. Do not leave it to dry outdoors. Oil the inner surface lightly with cooking oil (or Muurikka Silava Frying Fat). Fat protects against corrosion and improves the pan's frying qualities. Now your pan is ready for use. After each use, oil both the inner and outer surface of the pan lightly with oil.

Maintenance

A product of this type has no non-stick coating. Therefore pieces of food may stick to the surface. These are easy to remove if you leave some water and detergent in the pan for about an hour to soften the food. Then wash the pan with water and detergent. If necessary, you can also clean the pan with a rough sponge or washing powder.

When the pan is clean, dry it immediately and oil both the inner and outer surface lightly. Wrap the pan in paper, put it in a plastic bag and store it in a dry and protected place. If the

pan is not dried immediately after use, the inner surface may rust. Remove rust and/or burnt speckled brown layers of fat with a sponge, steel wool or a grill brush, wash with hot water and dry and oil the surface. A burnt speckled brown layer of fat that has formed on the surface as the pan has been used protects the pan against rust, and it is quite normal that the surface of a pan becomes multicoloured after the first use. Seasoning should be repeated whenever the layer has been damaged or washed off.

OUTDOOR AND PICNIC

Made for campfire! Muurikka is known as a manufacturer of durable camping pans, pots and kettles. The products are compact, light and easy to carry with you. High-quality and durable outdoor products also make excellent and desired gifts for those interested in camping and outdoor life. Good meals enjoyed by the campfire make your adventure unforgettable!



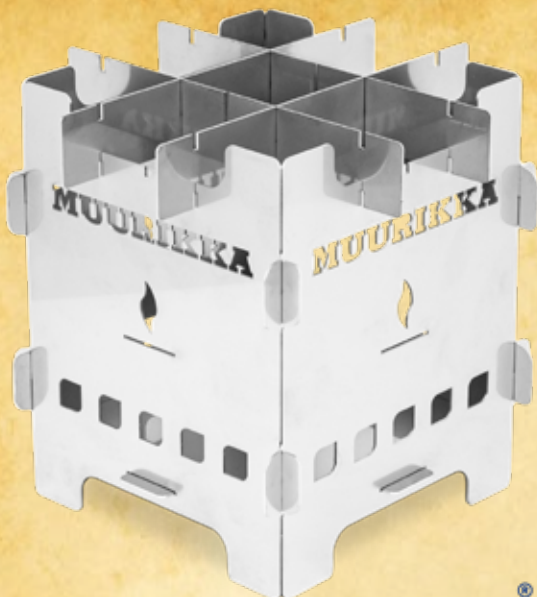

Outdoor Pocket Stove 54530020

Material: 0.8 mm thick stainless steel
Dimensions assembled: height 14 cm, width 10.8 cm and depth 10.8 cm
Weight of the Outdoor Pocket Stove: 0,450 kg
Dimensions of protective bag and packed stove: 15,7 x 16,4 x 1,5 cm
Weight with the protective bag: 0,480 kg



MUURIKKA OUTDOOR POCKET STOVE

With the Muurikka Outdoor Pocket Stove, you can prepare food or beverages outdoors. The stove is easy and fast to assemble, and it takes little space. The Muurikka Outdoor Pocket Stove is easy to carry in its small protective bag. Muurikka campfire coffee pots, camping frying pans and campfire cooking pots are compatible with the outdoor pocket stove. Dimensions 140 mm x 108 mm assembled. The Outdoor Pocket Stove is made of stainless steel in Finland.



MUURIKKA PRO THERMOS BOTTLE

The steel thermos bottle keeps the drink cold or hot for up to 24 hours. The thermos bottle has a double stainless steel construction, a rotating lid and handle made of 18/8 stainless steel and the bottle cap is made of bamboo. The exterior is coated with an environmentally friendly material which is BPA-free.

Base diameter: 7.3 cm
Height: 25.5 cm
Volume: 600 ml.



Muurikka PRO Thermos Bottle 54540090



Muurikka PRO Multitool 54540080

MUURIKKA PRO MULTITOOL

The multifunction tool is outdoor enthusiasts' best friend; you will never feel useless again. The tool fits perfectly in the hand and is durable, easy to use and sturdy. The tool includes a medium-sized and extra-small screwdriver, knife, saw, side cutters, tip pliers, Phillips-head screwdriver, bottle opener and nail file.

MUURIKKA SANDWICH IRON

With the Muurikka sandwich iron, you can prepare warm sandwiches with ease at the campfire or on the grill. Can also be used in the preparation of meat, fish or vegetable dishes. Durable cast iron retains heat exceptionally well. The wooden handle provides a good slip-free grip.

Product dimensions: 20.6 cm x 11 cm
Length: 70 cm.

Muurikka Sandwich Iron 54510030



MUURIKKA WAFFLE IRON

With the Muurikka waffle iron, you can prepare delicious and crispy waffles at the campfire or on the grill. Durable cast-iron retains heat exceptionally well. The wooden handle provides a good slip-free grip.

Dimensions: 16.2 x 9.3 cm
Length: 70 cm

Muurikka Waffle Iron 54510040



MUURIKKA TELESCOPIC SAUSAGE STICK

You can easily take the Muurikka Sausage Grilling Fork with you for all outings. Thanks to its telescopic handle it takes little space. Length extended 80 cm and folded 20.5 cm. Comes with a handy carrying bag.

Muurikka Telescopic Sausage Stick 54920870



NEW!

MUURIKKA HOB FOR OUTDOOR PANS

Hob for Outdoor Pans 54540060

High-quality, stainless steel hob for the campfire. Thanks to the sturdy legs, the hob stays in place. On top of that, you can use camping pans or pots and even make campfire coffee. Thanks to the folding legs, the hob does not take up much space and is easy to carry around in a protective bag.

Diameter: 33 cm
Height: 24 cm
Weight: 0.65 kg
Material: Stainless steel



MUURIKKA CAMPFIRE PAN, BLACK CARBON STEEL

A high-quality carbon steel pan with a long, folding handle. In its handy protective bag, it's easy to take with you for a picnic, to the cottage or camp site.

Diameter: Ø 24 cm
Handle length: 42 cm

Muurikka Campfire Pan, Black Carbon Steel 54520080



MUURIKKA CAMPFIRE FRYING PAN

Handy Campfire Pan needs very little space. You can make your own wooden handle and fasten it easily.

Material: hot-rolled steel
Size: Ø 23 cm
Weight: 0,5 kg

Muurikka Campfire Frying Pan 54510020



MUURIKKA LEISKU CAMPFIRE FRYING PAN

Light frying pan for camping, hiking, boating and caravanning. Has a foldable handle and cover bag.

Materiaali: hot-rolled steel, wooden handle
Size: 26 cm
Weight: 1,1 kg

Muurikka LEISKU Campfire Frying Pan 54510010



MUURIKKA OUTDOOR SMOKER FOR CAMPFIRE AND GAS GRILL

The Muurikka Outdoor Smoker can be used over a campfire or in a gas or charcoal grill with a suitable grating. Includes wire legs for using over open fire.

Size: 16 cm x 40 cm
Weight: 2,1 kg

 14 x 38 cm

Muurikka Outdoor Smoker for campfire and gas grill 54920610



MUURIKKA PROTECTIVE BAG FOR THE CAMPING SET

Protective bag can be used for storage and carrying campfire pot and/or kettle. The bag protects other items from soot. The bag has a loop for hanging it from your backpack, for example.

Size: 27 x 33 cm

Protective bag for the camping set 54540030



MUURIKKA GRID IRON

High-quality Grid Iron for open fire and on grills.

Material: stainless steel, wooden handle
Size: 19 cm x 28 cm (grill area) **Total length:** 76 cm

Muurikka Grid Iron 54920220

MUURIKKA SAUSAGE GRILLING FORK

Sausage Grilling Fork for open fire and on grills.

Material: stainless steel, wooden handle
Total length: 80 cm

Muurikka Sausage Grilling Fork 54920380



MUURIKKA CAMPFIRE KETTLE

Versatile water/coffee kettle for outdoor use. Shaped handle, easy to hang over the fire.

Material: stainless steel
Volume: 1,5 L and 3,0 L



Muurikka Campfire Kettle 1,5 L 54520020
Muurikka Campfire Kettle 3 L 54520030

MUURIKKA CAMPFIRE CASSEROLE

Thin bottom heats up rapidly over an open fire. Shaped handle, easy to hang over the fire.

Material: stainless steel
Volume: 2,3 L and 4,6 L



Muurikka Campfire Casserole 2,3 L 54520050
Muurikka Campfire Casserole 4,6 L 54520060

DESIGN
FROM
FINLAND

MUURIKKA OUTDOOR KETTLE

Outdoor Kettle 0,8L, stainless steel. The small coffee pot is easy to have with you wherever you go. Shaped handle, easy to hang up above the fire.

Muurikka Outdoor Kettle 0,8L 54520010



DESIGN
FROM
FINLAND

MUURIKKA OUTDOOR SET

Lightweight Set of Casserole & Kettle of compact size for outdoor use. Parts can be packed in one and into a protective bag with a loop to hang up the set on the backpack. Shaped handles, easy to hang up over the campfire. Both casserole and kettle are made of high-quality stainless steel.

Weight: 0,74 kg

Muurikka Outdoor Set: 54520070



DESIGN
FROM
FINLAND

MUURIKKA BROILING BOARD WITH GROUND SPIKE

Suitable for use by the campfire.

Material: Finnish birchwood, frame of stainless steel. **Size:** broiling board 50 cm x 14 cm x 2 cm
Length of ground spike: 27 cm

Muurikka Broiling Board with Ground spike 43001250



MUURIKKA CAMPING CHAIR

Foldable and lightweight Muurikka Camping chair with convenient carry bag, easy to pack and carry it to anywhere. Stable steel frame with long lasting and comfortable seat cover.

Muurikka Camping Chair 54920620



MUURIKKA COOLER BAG

Muurikka Cooler Bag with adjustable and padded carrying strap. Inside the bag pockets for ice bricks. Food and drinks stay cool inside the cooler bag about 12 hours and warm about 6 hours.

Material: polyester
Size: 29 x 23 x 33 cm

Cooler Bag 54920370



MUURIKKA BACKPACK COOLER

Muurikka Backpack Cooler is easy to bring along on your back to picnic, hiking and events. There are pockets for ice bricks inside the backpack. Food and drinks stay cool inside the cooler bag about 12 hours and warm about 6 hours.

Material: polyester
Size: 45 x 30 x 14 cm

Muurikka Backpack Cooler 54920430



ACCESSORIES

The experience of outdoor cooking is, of course, perfected by high-quality grilling tools and turners! When you cook with Muurikka, you need many kinds of tools – in our selections you'll find turners of different sizes, grill tongs, a turner for large pans, a grill fork, skewers, lighting tools and many other things.



MUURIKKA TURNER

This all-purpose spatula has the right amount of flexibility and strength for cooking and turning of steak, fish and other foods.

Material: stainless steel, wooden handle

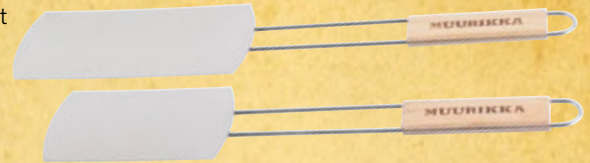

Muurikka Turner 42 cm 54920160
Muurikka Turner 48 cm 54920180

MUURIKKA MULTI- FUNCTION SPATULA

Spatula with a wide blade for turning and portioning of food easily. With this Spatula, it is also easy to clean Muurikka Grill and Griddle Pans, and griddles, as sides of blade are designed for cleaning.

Material: stainless steel, wooden handle

Size: length 36 cm



Muurikka Multi-Function Spatula
54920290

MUURIKKA SPATULA

The new size and shape of flexible blade makes it easier to use this spatula e.g. for flipping small pancakes. Ideal for use with the Muurikka Multifunctional Pan.

Material: stainless steel, wooden handle

Size: length 34 cm



Muurikka Spatula 54920070

MUURIKKA SPATULA

Spatula with flexible and long blade for many different kind of use.

Material: stainless steel, wooden handle

Size: length 46 cm



Muurikka Spatula 54920060

MUURIKKA GRILLING FORK

Strong Muurikka Grilling Fork with a handle that provides a firm grip.

Material: stainless steel,
wooden handle

Size: length 33.5 cm



Muurikka Grilling Fork 54920410

MUURIKKA WIDE SPATULA

Retro Design model of Muurikka Spatula with wide blade for turning and portioning of food easily. Ideal for use with the Original Muurikka 100 Pan.

Material: stainless steel,
wooden handle

Size: length 33 cm



Muurikka Wide Spatula 54920400

MUURIKKA LARGE SPATULA

New size and shape of Muurikka spatula for turning and portioning of food easily. Ideal for use with the Original Muurikka 100 Pan.

Material: stainless steel, wooden handle

Size: length 60 cm



Muurikka Large Spatula 54920390

MUURIKKA PAELLA- SKIMMER

Large Skimmer which is ideal for mixing and portioning out e.g. paella type of food.

Material: stainless steel,
wooden handle

Size: 38 cm

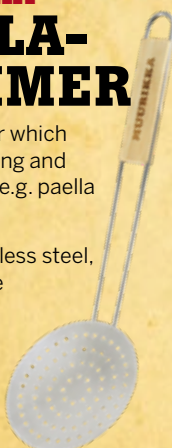

Muurikka
Paella Skimmer
54920310

MUURIKKA FISH HOLDER

This Fish Holder has firm grip on a shaped handle with rubber coating. The prongs are made of stainless steel, and the product is dishwasher-proof.



Muurikka
Fish Holder
54920110

MUURIKKA FISH TWEEZER

Fish tweezer made of stainless steel. Good shape provides a firm grip and makes it easy to remove individual bones.



Muurikka Fish Tweezers 54920280

MUURIKKA MUSHROOM KNIFE

Handy Mushroom Knife with an elegant and comfortable wooden handle, folding blade, cleaning brush, tweezers and hanging loop.

Package includes: cover bag with belt loop.

Material: stainless steel, wooden handle



Muurikka Mushroom Knife 54920260

MUURIKKA PREMIUM STOOL

NEW!

Muurikka Stool is a seat suited for indoor and outdoor use. The stool can also be used as an additional seat or a side table on a terrace, balcony or next to a Tundra Grill. The stool is made of aluminium painted black, which makes the stool sturdy and yet light to move around. The seat is made of heat-treated Finnish pine. The height from floor to seat is 43 cm, width 35 cm (depth of the seat 29.5 cm)



Muurikka Premium Stool 54930010

MUURIKKA PRO PLASMA LIGHTER

Muurikka plasma lighter is a long-stemmed universal lighter without gas or fire. It safely lights candles, a fireplace, a wood-heated sauna and gas burners without burning your fingers. The body of the plasma lighter is made of durable steel. USB rechargeable.

Muurikka PRO Plasma Lighter 54920770



NEW!

MUURIKKA PRO WHETSTONE

Whetstone with a bamboo holder. The silicone base ensures that the stone stays in place when grinding. The stone comes with two different grits 1000/6000.

Muurikka PRO Whetstone 54920810



NEW!

MUURIKKA PRO DAMASCUS KNIVES

NEW!

The Muurikka PRO Damascus knives are made of high-quality VG10 steel. The extremely sharp and durable Damascus knife is made using the traditional method where the metal is repeatedly folded until the surface of the blade shows a beautiful and unique 67-layer moulded Damascus pattern. The handle is made of fibreglass and epoxy-based G10 material, which offers a firm grip on the handle. The material is durable, maintenance-free and also suitable for humid conditions.

MUURIKKA PRO CHEF'S KNIFE, DAMASCUS

Knife length 32.3 cm
Blade length 19 cm
Blade width 4.1 mm
Blade thickness 2.5 mm



Muurikka PRO Chef's Knife, Damascus 54920790

MUURIKKA PRO FILLETING KNIFE, DAMASCUS

Knife length 33.8 cm
Blade length 20.5 cm
Blade thickness 2 mm



Muurikka PRO Filleting Knife, Damascus 54920780

MUURIKKA PRO VEGETABLE KNIFE, DAMASCUS

Knife length 27.5 cm
Blade length 14 cm
Blade width 4.0 mm
Blade thickness 2.5 mm



Muurikka PRO Vegetable Knife, Damascus 54920800

MUURIKKA GRILL PRESS, ROUND

NEW!

The cast iron Muurikka steak press is suitable for use on both grills and pans. With the steak press, you make delicious Smash Burgers, which are pressed against the cooking surface with a sturdy wooden handle press.

Diameter: 18 cm
Weight: 1 kg

Muurikka Grill Press, round 54920840



MUURIKKA GRILL PRESS, RECTANGLE

NEW!

The cast iron Muurikka steak press is suitable for use on both grills and pans. With the steak press, you make delicious Smash Burgers, which are pressed against the cooking surface with a sturdy wooden handle press.

Dimensions: 10.5 x 20.5 cm
Weight: 1 kg

Muurikka Grill Press, rectangle 54920850



MUURIKKA CHEF KITCHEN TOWEL

Black kitchen towel with Muurikka logo
Size: 50 x 70 cm
Material: 100% cotton

54920670



MUURIKKA HALF APRON

Black half apron with Muurikka logo.
Material: 65% polyester / 35% cotton. **Size:** 52 x 77 cm

54920680



MUURIKKA APRON

Black apron with Muurikka logo. Stylish apron protects you and your clothing from splashes. Front pocket. Tie in the back straps at the waist.

Size: 94 x 65 cm
Material: 65 % polyester, 35 % cotton

Muurikka
Apron
54920650

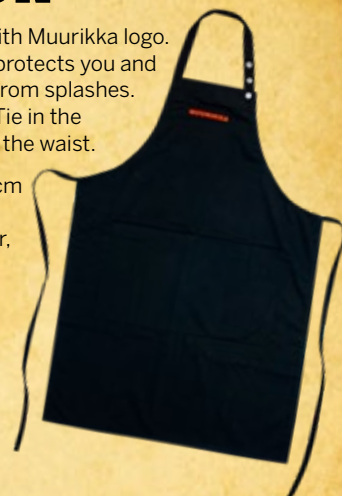

MUURIKKA GAS HOSE WITH LOW PRESSURE REGULATOR

Gas hose with low pressure regulator, easy to connect.

Length 1.2 m.



Gas Hose with low pressure regulator
54130000

MUURIKKA PRO GRILL GLOVES

The outside of the Muurikka PRO Grill and smoking glove is made of leather and the inside is made of incombustible and very heat-resistant aramid fibre. The gloves are safe and pleasant to use, and you can handle hot pots and pans safely. The gloves also protect you against glowing sparks and flames.



Muurikka PRO Grill gloves
54920590

MUURIKKA PRO LEATHER APRON

High quality genuine leather apron. The stylish apron provides protection from heat as well as hot-liquid splashes and sparks both when grilling and when cooking in the kitchen. Adjustable neck strap and tie in the back straps at the waist. Straps are made of soft suede.

Size: 93 x 64 cm

54920660



MUURIKKA BOILING AND FRYING MAT FOR GAS BURNERS



This Mat enables the easy use of different-sized pots and pans on the top of Gas Burner D-300, D-350 and D-400.

Material: enamelled steel Ø 35 CM

Muurikka Boiling and Frying Mat for Gas Burners 54920470

MUURIKKA STEAK KNIVES 6 PCS.

The serrated steak knives are particularly suited for cutting meat. They can also be used as universal knives.

Steak Knives
54920820



MUURIKKA GRILL TONGS

Grill Tongs of stainless steel. Can also be used as Salad Servers.

Two sizes
29/38 cm



Muurikka
Grill Tongs 29 cm
54920100

Muurikka
Grill Tongs 38 cm
54920200

MUURIKKA SKEWERS 4 PCS.

Strong and long steel skewers can hold a great number of food bits to be grilled. The flat shape of skewers helps food pieces remain in place while skewers are turned. Package has four skewers.

Material: stainless steel
Size: length 40 cm



Muurikka Skewers 4 pcs
4 kpl 54920170

MUURIKKA KINDLIN WOOD ROLLS

For lighting fireplaces, barbecues, campfires etc.

Material: pinewood mass soaked in paraffin wax.

Burning time:
8-10 minutes.

Package: 32 rolls.



Muurikka
Kindlin Wood Rolls
54920340

MUURIKKA GRILSTER

With Muurikka Grilster steaks, chickens, fish, sausages or toasts are easy to grill on both sides, as when turning with grilster there is no risk of food falling down. Grilster can be used on all kind of grills and over an open fire. When opened, Grilster can be used as an ordinary griddle.

Diameter:
Ø 40 cm.



Muurikka Grilster
54920250

MUURIKKA MULTI- CLEANER

Ecological Muurikka MultiCleaner is an effective substance with no perfumes, colouring agents or preservatives. It cleans, polishes and protects almost any kinds of surface, and removes ingrained stains and difficult dirt without corroding or scratching. Not for cleaning of Muurikka Griddle Pans.

Size: 400 g



Muurikka
MultiCleaner
54920030

MUURIKKA WARMING PLATE

Warming Plate for a variety of Muurikka pans. There is a place for six tealight candles on the plate. Keeps food warm and creates a nice atmosphere. Package is without tealight candles.

Material:
stainless steel
Size: Ø 32 cm



Muurikka
Warming Plate
54920440

MUURIKKA GRILL BRUSH

Grill Brush with scraper. Use this grill brush to remove the most difficult stains from your grills.

Material: brass (brush part), steel (scraper), wooden handle
Size: 31 cm



Muurikka Grill Brush
54920230

MUURIKKA GRILL BRUSH

Silicone grill brush with wooden handle. Suitable for spreading grill sauces and marinades.

Muurikka Grill Brush
54920700



MUURIKKA SILICONE BRUSH HEADS, 2 PCS

Replacement silicone brush heads for Muurikka grill brush.

Silicone brush heads, 2 pcs
54920710



MUURIKKA
GRILL GRID WITH LEGS AND HANDLE

Stable Grid with removeable handle for open fire with legs of 13 cm and removable handle. **Material:** steel / chrome

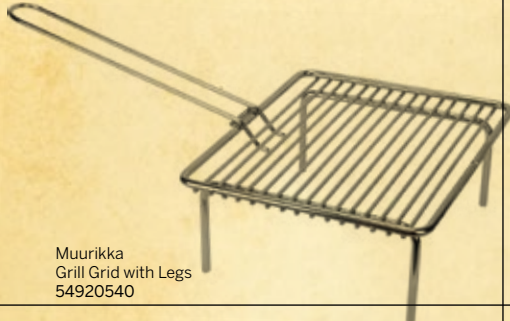

Muurikka Grill Grid with Legs 54920540

MUURIKKA
WIRELESS MEAT THERMOMETER

This digital Thermometer shows you the exact temperature of the food you are grilling or smoking even at a distance of 20 meters. Batteries are included.



Muurikka Wireless Meat Thermometer 54920150

MUURIKKA
MEAT THERMOMETER

Traditional digital Meat Thermometer shows you exactly when your food is done.



Muurikka Meat Thermometer 54920140

MUURIKKA
SUMMER KITCHEN CASSEROLE

Casserole for easy outdoor boiling while cooking or grilling. Compatible with Muurikka Summer Kitchen Gas, and Gas Burners of models: D-300, D-350 and D-400. Suitable also for cookers and for open fire.

Material: stainless steel



Muurikka Summer Kitchen Casserole 15 L 54090010

MUURIKKA
BLANCHING BASKET

Blanching Basket for Muurikka Summer Kitchen Casserole. The Basket makes it easy to rinse and strain mushrooms, shellfish and other foods.

Material: stainless steel



Muurikka Blanching 54090020

MUURIKKA
CHOPPING BOARD

Material: Acacia wood
Size: 38 cm x 30 cm x 2 cm



Muurikka Chopping Board 54920120

MUURIKKA
PIZZA STONE

With the Muurikka Pizza Stone, you can bake restaurant-level, crispy pizzas at home. Also ideal for baking frozen pizzas. On the Pizza Stone, you can also bake bread, rolls, pies and other pastries. The Pizza Stone works particularly well in a kitchen oven or a grill – for example the Muurikka Outdoor Oven. The round Pizza Stone is easy to move with its handy carry handles.

Material: ceramically coated cordierite
Diameter: 33 cm

Muurikka Pizza Stone 54920600

Favorite Products



MUURIKKA
PIZZA SPATULA

Lift and move pizzas effortlessly with Muurikka Pizza Spatula. Sturdy wooden handle provides firm grip.



Muurikka Pizza Spatula 54920460

TUNDRA GRILLS

Place your Tundra Grill in your garden, outside your cottage or wherever people gather to cook and enjoy good food together. All Tundra Grills are made of durable, high-quality Finnish steel in Finland. Our durable quality is guaranteed by careful product testing, first-class materials, strict quality control and thorough assembly.



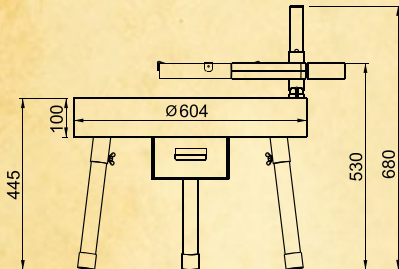

TUNDRA GRILL® NOTSKI 60

Tundra Grill Notski – your ready-to-use campfire pit! The Tundra Grill Notski is a compact and easily movable firebowl. It has one swing-out skillet for different kinds of Muurikka pans.

Notski is a ready-to-use campfire pit with sufficient air supply, which makes it easier to light a campfire. Notski is easy to place in the desired location, and ready for use.

Notski is very easy to assemble and disassemble for storage, and it does not take up much storage space. Notski is made of high-quality Finnish steel, and its surfaces have been treated with highly heat-resistant coating.

- one adjustable skillet, dia 25cm
- one ash box
- one ash rake
- one reversible grate

Material: steel
Dimensions: firebowl Ø 60 cm
 working height is adjustable between 53-63 cm
 Swing-out Skillet Ø 25 cm



Tundra Grill Notski, 43006100

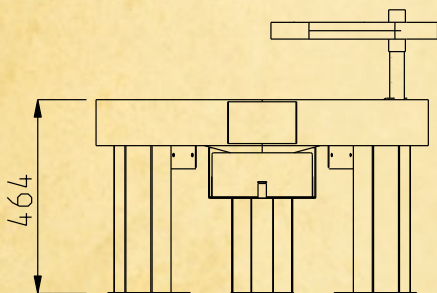

TUNDRA GRILL® NOTSKI 80 AND 100

Heart of the traditional Tundra Grill is now available as an individual product with one swing-out skillet for different kinds of Muurikka Pans. Notski 80 and 100 is a ready-to-use campfire pit with sufficient air supply, which makes it easier to light a campfire. Notski is made of high-quality Finnish steel. Notski is made of high-quality Finnish steel, and its surfaces have been treated with highly heat-resistant coating.

TUNDRA GRILL® NOTSKI 80 and 100

- one adjustable skillet, Ø 38 cm
- one ash box
- one ash rake
- one reversible grate

Material: steel
Dimensions: firebowl Ø 80 / 96 cm
 working height 45 cm
 Swing-out Skillet Ø 38 cm

Tundra Grill Notski 80 43006300
 Tundra Grill Notski 100 43006400



TUNDRA GRILL® CITY

The stylish Tundra Grill City is a compact model combining an outdoor fireplace for creating warm atmosphere, and an open grill for outdoor cooking. The unique rotating door with a spark protection mesh guarantees the comfort and safety, when using the model on terraces or inside a garden pavilion. Enjoy living flames by using firewood, briquettes or charcoal!

The fire bowl is fully protected by a fixed back wall and the rotating door is protecting against burning sparks. Made of thick, high-quality Finnish steel.

Tundra Grill City

- 1 hood and rain cap
- 1 rotating door with spark protection mesh
- 1 adjustable skillet with wooden handle
- 1 Original Muurikka Pan 38 cm
- 1 Muurikka Kindlin Wood Rolls
- 1 ash rake, ash box, turnable grate

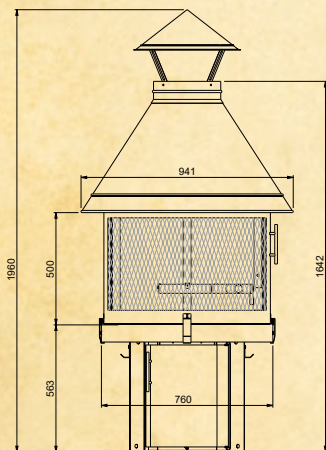

TUNDRA GRILL® CITY
LOW MODEL

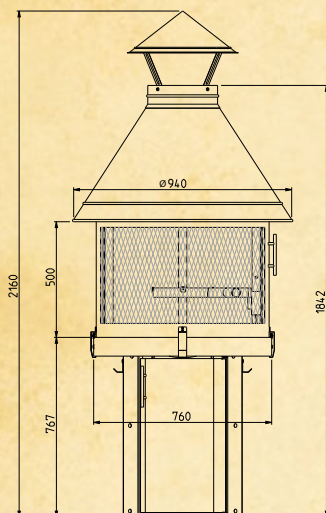

TUNDRA GRILL® CITY
HIGH MODEL



*Tundra Grill's antique silver-coloured smoke hoods are made-to-order products, minimum order 20 pcs.

LOW MODEL

Material: steel
Colours: black, antique silver
Dimensions: total Ø 94 cm
firebowl Ø 58 cm
working height 56 cm

Tundra Grill® City, Low model
black 43006000

*Tundra Grill® City, Low model
antique silver 43007000

HIGH MODEL

Material: steel
Colours: black, antique silver
Dimensions: total Ø 94 cm
firebowl Ø 58 cm
working height 80 cm

Tundra Grill® City, High model
black 43006050

*Tundra Grill® City, High model
antique silver 43007050

TUNDRA GRILL® 80

Tundra Grill Model Basic 80 and 100 are available as a low version with three-legged stand, and as a high version with shelved stand. Swing-out skillets can be adjusted by putting the pin into desired height of the pole.

Tundra Grill Model Basic 80

- 1 hood and rain cap
- 2 adjustable swing-out skillets with wooden handles
- 1 bbq rack 38 cm
- 1 Original Muurikka Pan 38 cm
- 1 Muurikka Fish Broiling Board with frame
- 1 Muurikka Kindlin Wood Rolls
- 1 ash rake, ash box, turnable grate

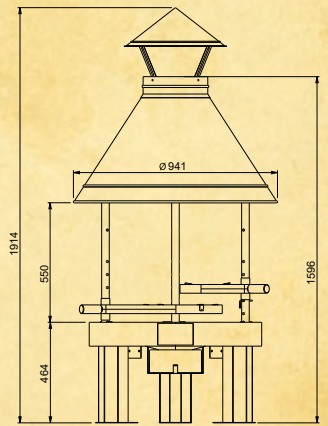

TUNDRA GRILL® 80
LOW MODEL

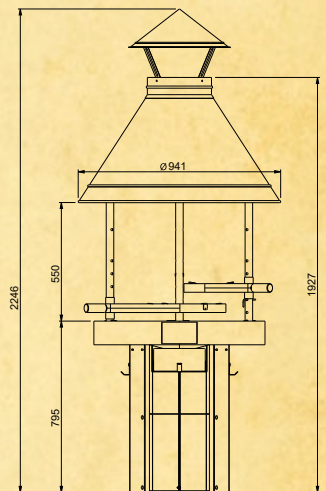

TUNDRA GRILL® 80
HIGH MODEL

LOW MODEL

Material: steel
Colours: black,
Dimensions: total Ø 94 cm
firebowl Ø 80 cm
working height 45 cm

Tundra Gril 80
low model, black
43001270

HIGH MODEL

Material: steel
Colours: black,
Dimensions: total Ø 94 cm
firebowl Ø 80 cm
working height 80 cm

Tundra Gril 80 high model,
black 43001273
*Tundra Gril 80 high model,
antique silver 43001300

**Equip your
Tundra Grill
as you like!
See compatible
products from
page 46**

TUNDRA GRILL® 100

Tundra Grill Model Basic 80 and 100 are available as a low version with three-legged stand, and as a high version with shelved stand. Swing-out skillets can be adjusted by putting the pin into desired height of the pole.

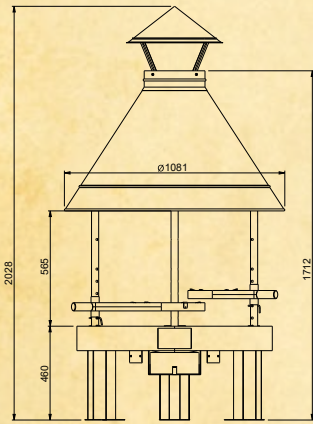

TUNDRA GRILL® 100
LOW MODEL

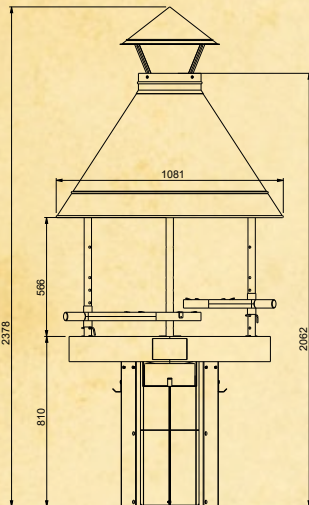

TUNDRA GRILL® 100
HIGH MODEL

Tundra Grill Model Basic 100

- 1 hood and rain cap
- 2 adjustable swing-out skillets with wooden handles
- 1 bbq rack 38 cm
- 1 Original Muurikka Pan 38 cm
- 1 Muurikka Fish Broiling Board with frame
- 1 Muurikka Kindlin Wood Rolls
- 1 ash rake, ash box, turnable grate



LOW MODEL

Material: steel
Colours: black,
Dimensions: total Ø 108 cm
 firebowl Ø 96 cm
 working height 45 cm

Tundra Grill 100
 low model, black
 43001276

HIGH MODEL

Material: steel
Colours: black,
Dimensions: total Ø 108 cm
 firebowl Ø 96 cm
 working height 80 cm

Tundra Grill 100
 high model, black
 43001279

Equip your
 Tundra Grill
 as you like!
 See compatible
 products from
 page 46

TUNDRA GRILL® BBQ

Tundra Grill Model BBQ is the flagship product combining the modern design and excellent usability. BBQ has a lifting mechanism of skillets, which makes it easier to cook your dishes at a right temperature.

Tundra Grill BBQ models are available as a low version with door-stand and as a high version with door-stand. Swing-out skillets can be adjusted by lifting mechanism.

Tundra Grill Model BBQ

- 1 hood and rain cap
- 2 adjustable swing-out skillets with lifting mechanism and wooden handles
- 1 bbq rack 38 cm
- 1 Original Muurikka Pan 38 cm
- 1 Muurikka Fish Broiling Board with frame
- 1 Muurikka Kindlin Wood Rolls
- 1 ash rake, ash box, turnable grate

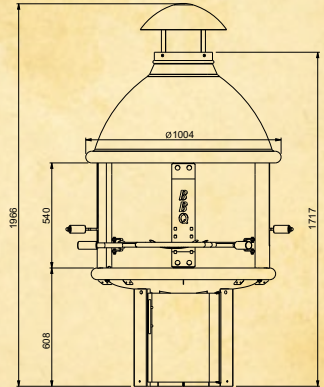

TUNDRA GRILL® BBQ
LOW MODEL

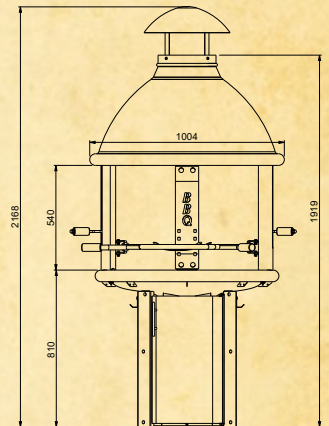

TUNDRA GRILL® BBQ
HIGH MODEL

LOW MODEL

Material: steel
Colours: black,
Dimensions: total Ø 100 cm
firebowl Ø 80/95 cm
working height 60 cm

Tundra Grill BBQ
low model, black
43001465

HIGH MODEL

Material: steel
Colours: black,
Dimensions: total Ø 100 cm
firebowl Ø 80/95 cm
working height 80 cm

Tundra Grill BBQ
high model, black
43001420



TUNDRA GRILL MODEL HEAVY DUTY

Tundra Grill Model Heavy Duty, HD, is designed particularly for heavy and regular use, as the firebowl is made of thicker material. Swing-out skillets can be adjusted by putting the pin into desired height of the pole.



Heavy Duty is designed particularly for heavy and regular use, as the firebowl is made of thicker material

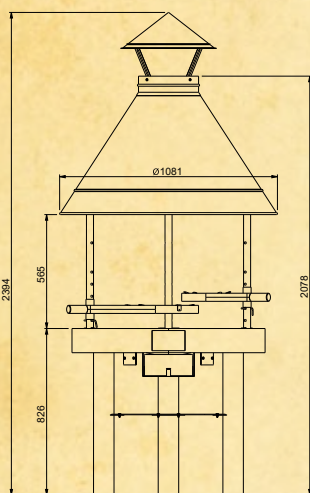

TUNDRA GRILL®
HEAVY DUTY
HIGH MODEL



Tundra Grill® Heavy Duty Model

- 1 hood and rain cap
- 2 adjustable swing-out skillets with wooden handles
- 1 bbq rack 38 cm
- 1 Original Muurikka Pan 38 cm
- 1 Muurikka Fish Broiling Board with frame
- 1 Muurikka Kindlin Wood Rolls
- 1 ash rake, ash box, turnable grate

Material: steel
Colours: black,
Dimensions: total Ø 108 cm
firebowl Ø 96 cm
working height 80 cm

**TECHNICAL INFORMATION
AND OWNER'S MANUAL AT**



muurikka.com

Tundra Grill Heavy Duty,
black 43001289



Take good care of your Tundra Grill!

Made of high-quality materials, the Tundra Grill resists time, wear and tear. With regular maintenance, your Tundra Grill will last a lot longer, and you will always be sure to have an excellent product for cooking.

Maintenance:

After use, always carefully remove the ashes from the furnace in the Tundra Grill. Before doing so, make sure that there are no glowing embers, cinders or other burning material that could start a fire. The easiest way to remove the ashes is to brush the ashes down into the ash pan through the hole in the middle of the furnace. It is easy to empty the ash pan e.g. into a metal bucket. Please note that the ash pan may be hot, so use an oven glove when you lift the ash pan. If your Tundra Grill is not to be used for some time, you can grease the furnace lightly with cooking oil. Oil protects the furnace surface against rust and corrosion.

















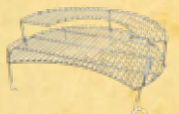

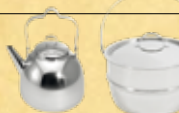

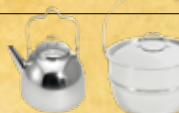



















It is also a good idea to clean the surface of the smoke hood, the frying surfaces and the foot part regularly. You can use a moistened cloth to clean these surfaces. If there is ingrained

dirt on the surfaces, you can add a small drop of detergent to the water.

If your Tundra Grill should get scratched or some of the paint should wear in spite of your maintenance, we recommend that you touch up the worn painted surface with Tundra Grill touch-up paint as soon as possible. First carefully remove the soot and the fat from the spot to be touched up, and let it dry. If the worn spot is already rusty, remove the rust carefully before painting. When the spot is clean and dry, treat it with Tundra Grill touch-up paint according to the instructions on the package. The paint is available through our dealers, at Opa Muurikka shops and online.

NOTE! The only Tundra Grill touch-up paint available is black

TUNDRA GRILL® Accessories and Equipment

<p>Wind Deflector</p>				
<p>Barbeque Racks • dia 68 cm • two levels dia 58 cm</p>				
<p>Campfire Casserole Campfire Kettles</p>	 3,0l /1,5l 4,6l /2,3l	 3,0l /1,5l 4,6l /2,3l	 3,0l /1,5l 4,6l /2,3l	 3,0l /1,5l 4,6l /2,3l
<p>Summer Kitchen Casserole 15 l</p>			<p>×</p>	<p>×</p>
<p>Smoking Containers</p>				
<p>Steel Paella Pans</p>	 50 cm • 40 cm	 60 cm • 50 cm • 40 cm	 40 cm	 40 cm
<p>Steel Wok Pans</p>	 40 cm	 40 cm	 40 cm	 40 cm
<p>Muurikka Wok Pan</p>				
<p>Cast Iron Pans • Pan with Sections • Multifunctional Pan • Grill Pan • Paella Pan</p>				
<p>Original Muurikka Pans</p>	 78 cm • 58 cm • 48 cm	 58 cm • 48 cm	 48 cm • 38 cm	 48 cm • 38 cm
<p>TUNDRA GRILL® MODELS</p> <p>Choose extra equipment and accessories for your Tundra Grill, as well as compatible Muurikka products.</p>	 TUNDRA GRILL® 80, 100, HD & SPECIAL EDITION TUNDRA GRILL® NOTSKI 80 JA 100	 TUNDRA GRILL® BBQ	 TUNDRAGRILL® CITY	 TUNDRA GRILL® NOTSKI 60

ACCESSORIES

A wide selection of different accessories is available for Tundra Grills. You can choose compatible Muurikka pans, casseroles, smoking containers, bbq racks and skewers. On a wide bbq rack you can prepare delicious dishes for a large number of people, and flame fish with the broiling boards easily. With a campfire kettle hanging up in a hook you can make coffee! Windshields are very useful accessories by windy weather. The cover protects the Tundra Grill against dirt and moisture.



TUNDRA GRILL®

ACCESSORIES

Which accessories makes your Tundra Grill perfect?

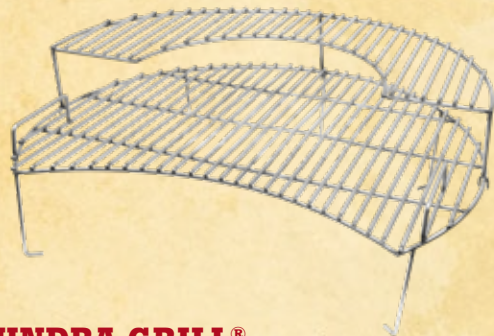

TUNDRA GRILL® BARBEQUE RACK WITH TWO LEVELS

New half-circle shaped barbecue rack of two levels for all Tundra Grill models. The upper level rack can be removed.

Material: Stainless steel

Diameter: 58 cm

Height: 22 cm

Barbeque Rack with two levels
43001131



TUNDRA GRILL® PROTECTIVE COVER

Suitable for all models.

Material: teflon/polyester **Colour:** Black

Tundra Grill Protective Cover
43001400

TUNDRA GRILL® BARBECUE RACK

Material: stainless steel

Dimension: Ø 38 cm

Tundra Grill Barbecue Rack
43001194



TUNDRA GRILL® BARBEQUE RACK 25 CM

Material: Stainless steel

Diameter: 25 cm

For Tundra Grill models:
City, Basic 80/100,
Heavy Duty,
Notski 60

Barbeque Rack
25 cm
43001195



TUNDRA GRILL® GRILL PLATE WITH LEGS 60 CM



Made of thick steel, the grill plate is an accessory for the Tundra Grill. On top of the frying pan you can grill food and through the hole in the middle you can add wood and improve the fire. Compatible with all Tundra Grill models (except Tundra Grill City).

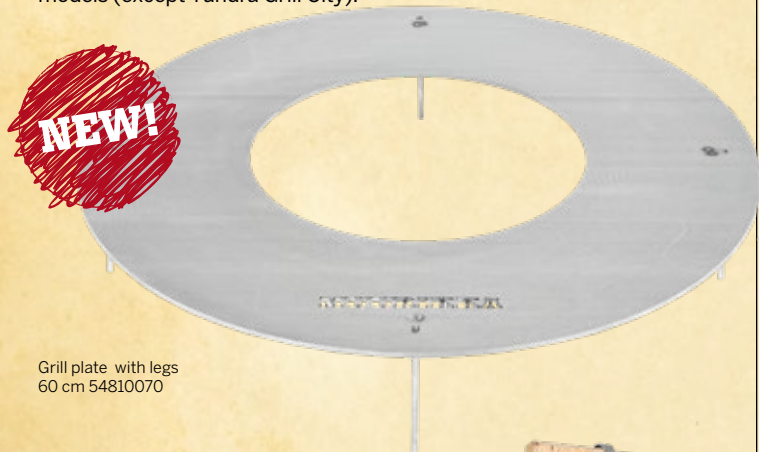

Grill plate with legs
60 cm 54810070

TUNDRA GRILL® BARBEQUE RACK 68 CM

Large barbeque rack 68 cm for all Tundra Grill models (except models Garden, City, Notski 60)

Material: Stainless steel, **Size:** Ø 68 cm

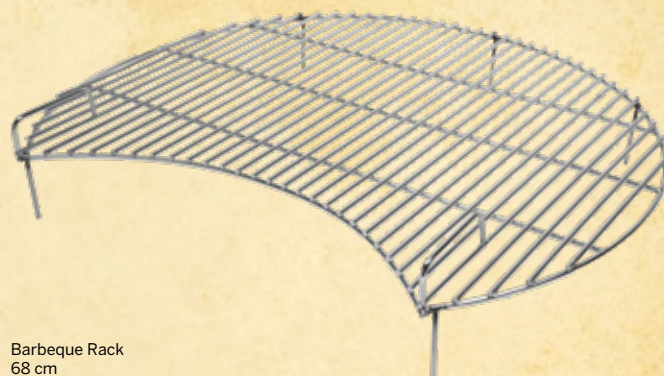

Barbeque Rack
68 cm
43001130

TUNDRA GRILL® BROILING BOARD

Suitable for all Tundra Grill models.

Material: : Finnish birchwood, frame of stainless steel

Size: 50 x 14 x 2 cm.

Tundra Grill
Broiling Board
with Frame
43001142



TUNDRA GRILL® CAMPFIRE BARBEQUE

Campfire barbeque with height adjustable swing-out skillet with barbeque rack, also suitable for different kinds of Muurikka pans. The pole can be fastened to a solid base with screws or anchored into the ground next to your campfire.

Height: 91 cm **Size:** Ø 38 cm

Material: steel, bbq rack of stainless steel

Campfire Barbeque
43001330



MUURIKKA ASH BUCKET

An ash bucket with a tight lid and a wooden carrying handle.

Volume: 25 L

Muurikka Ash bucket
54920420



TUNDRA GRILL® SKEWER SET

Tundra Grill Skewer Set, 3 pcs Skewers can be used with the metal holder of Fish Broiling Boards.

Material: stainless steel

Set: 3 pcs of skewers

Length: 53cm

Tundra Grill Skewer Set
43001190



TUNDRA GRILL® COFFEE POT HOOK

The coffee kettle hook is compatible with Tundra Grill Notski 80 and 100, Tundra Grill 80, 100 and HD models. You can hang a coffee kettle or campfire cooking pot from the hook.



Coffee Pot Hook P430117400

TUNDRA GRILL® WIND DEFLECTOR

Suitable for all models

Material: steel
Dimensions:
30 x 62,5 cm



Tundra Grill
Wind Deflector
43001149

SIDE TABLES

Side tables are a convenient equipment to the Tundra Grill. The side tables functions as a small worktop and creates extra space for additional grilling utensils during cooking, and works as serving trays while eating.



TUNDRA GRILL® MODEL BASIC 80/100

Material: laminated birch / pinewood
Colours: hazel-colored wood-oil
Measurements: Thickness 12 mm - 18 mm
Width: 210 mm • Length: 590 mm

Tundra grill® side tables for models BASIC 80/100 laminated birch, hazel-colored wood-oil 43001411

Tundra grill® side tables for models BASIC 80/100 pinewood, hazel-colored wood-oil 43001412

TUNDRA GRILL® BASIC 80/100 AND HEAVY DUTY

Material: laminated birch
Colour: hazel-colored wood
Measurements: Thickness 120 mm
Width: 350 mm • Length: 760 mm

Tundra grill® side tables for models BASIC 80/10 and HEAVY DUTY laminated birch hazel-colored wood 43001424

TUNDRA GRILL® MODEL BBQ

With folding mechanism

Material: pinewood
Colours: hazel-colored wood-oil
Measurements: Thickness 250 mm
Width: 210 mm • Length: 750 mm

Tundra grill® side tables for model BBG 43001134



TUNDRA GRILL® FIREPLACE BOWL 80

Installation requires an angle grinder.

Material: steel • Colour: ●
Dimensions: firebowl Ø 80 cm



Tundra Grill Fireplace Bowl 80 black 43001171

TUNDRA GRILL® FIREPLACE BOWL 100

Installation requires an angle grinder.

Material: steel • Colour: ●
Dimensions: firebowl Ø 96 cm



Tundra Grill Fireplace Bowl 100 black 43001172

TUNDRA GRILL® FIREPLACE BOWL BBQ

Installation requires an angle grinder.

Material: steel • Colour: ●
Dimensions: firebowl Ø 80 cm

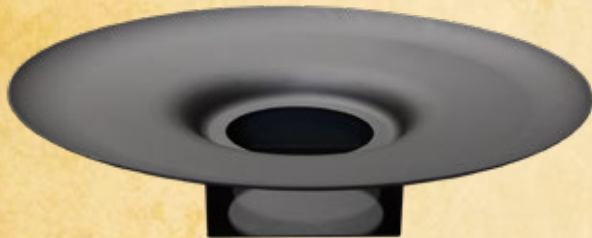

Tundra Grill Fireplace Bowl BBQ 43001175

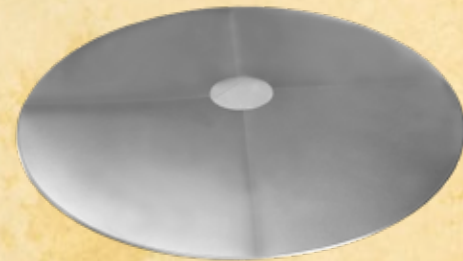

TUNDRA GRILL® FLOOR PROTECTION SHEETS

For Models Basic 80, Notski 80, City

Material: zinc or stainless steel • Measurement: Ø 180 cm

Tundra Grill Floor Protection Sheet 180 zink 43001431

Tundra Grill Floor Protection Sheet 180 stainless steel 43001433

For Models Basic 100, Notski 100, BBQ and Apetivo

Material: zinc or stainless steel • Measurement: Ø 200 cm

Tundra Grill Floor Protection Sheet 200 zink 43001432

Tundra Grill Floor Protection Sheet 200 stainless steel 43001434

Fireplace bowl replacement bases are available for Tundra Grill models 80, 100 and BBQ. The replacement base is placed on the old base. Use Tundra Grill Floor Plate to protect environment around the Tundra Grill from ash and glowing embers. The Floor Plate is available in two sizes.

Fireplace Bowls

The new Fireplace Bowl is installed on the old one. To install the new bowl, you will need an angle grinder to cut off the ash box-sized piece of the old bowl. The new bowl is installed so that the ash door of the new bowl goes through the hole. The bowl has been placed correctly when the welds of the old and new one are aligned.



CHIMNEY SETS

The outer flue included in the chimney set assembly can only be used in buildings with no heat insulation or suspended ceilings. When planning to install Tundra Grill in a building with heat insulation or suspended ceilings, a custom-made fire-insulated bushing is needed. Please always observe local fire safety regulations when installing Tundra Grill fireplace indoors.



Outer Flue The purpose of the outer flue is to secure that the chimney to be led through the roof will be at a safe distance from the roof structures. The outer flue should be slipped through a hole made in the roof from the outside into the building. The flue will then hang by its bushing collar on the rooftop. The chimney extensions should be slipped through the outer flue from the outside into the building and fastened to the Tundra Grill hood.

Chimney Extensions The number of chimney extensions needed inside the building is obtained by measuring the total distance from the ceiling to the upper edge of the hood. Please always observe local fire safety regulations when planning the chimney extension above the rooftop. The chimney draws better when the height of the chimney on the roof exceeds the minimum requirements.

When calculating the total dimensions and number of the chimney extensions needed, it should be considered that each coupling point of extensions makes the chimney's total height 40 mm smaller. We recommend that all joints between chimney extensions be secured with drilling sheet metal screws or heat-resistant glue paste so the chimney will stay in place even in stormy weather.

The rain collar should be fastened to the chimney above the outer flue. Its purpose is to prevent rain-water from coming into the building through the gap between the chimney and the outer flue.

With the closing valve chimney you can regulate draught and heat inside the building. The valve must be open whenever there is fire in the Tundra Grill. While the valve is closed, more heat will remain inside the building. With the shutter valve, small animals and litter can be prevented from entering the building through the chimney.

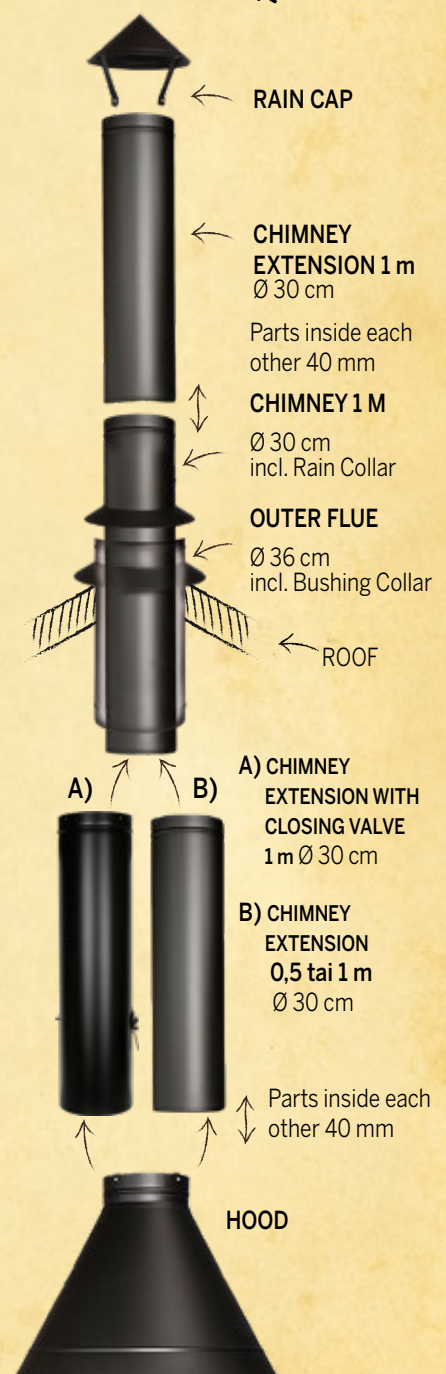

TUNDRA GRILL® CHIMNEY SET 2 X 1M



Material: steel

Colour: ●●

Dimensions: 2 x 1 m

Set includes: Outer flue (Ø 36 cm) with Bushing Collar, Chimney Extension with Rain Collar (Ø 30 cm, 1 m), Extension Chimney (Ø 30 cm, 1 m)

Chimney Set For Tundra Grill 2x1m black 43001153

Chimney Set For Tundra Grill 2x1m antique silver 43001166

TUNDRA GRILL® CHIMNEY SET 1M + 0,5M



Material: steel

Colour: ●●

Dimensions: 1 m + 0,5 m

Set includes: Outer flue (Ø 36 cm) with Bushing Collar, Chimney Extension with Rain Collar (Ø 30 cm, 1 m), Extension Chimney (Ø 30 cm, 0,5 m)

Chimney Set For Tundra Grill 1m+0,5m black 43001155

Chimney Set For Tundra Grill 2x1m antique silver 43001167

TUNDRA GRILL® CHIMNEY EXTENSION, 0,5M OR 1M



Material: steel

Colour: ●●

Dimensions: 0,5 m / 1 m

Chimney Extension For Tundra Grill 0,5 m black 43001188
Chimney Extension For Tundra Grill 0,5 m antique silver 43001170
Chimney Extension For Tundra Grill 1 m black 43001165
Chimney Extension For Tundra Grill 1 m antique silver 43001168

TUNDRA GRILL® INSULATED CHIMNEY SET



Material: stainless steel, aluzink and fire-resistant mineral wool • **Colour:** ●

Dimensions: 1 m

Contents: chimney inside diameter Ø 300 mm outside diameter 350 mm fire-resistant mineral wool 25 mm density 125 kg/m³

Contains: insulated chimney 1 m, carrying collar, fitting parts Ø 300 mm for Tundra chimneys x 2

Insulated chimney 1m 43001310

TUNDRA GRILL® INSULATED EXTENSION CHIMNEY 1M/0.5M



Material: stainless steel, aluzink and fire-resistant mineral wool • **Colour:** ●

Dimensions: 0,5 m / 1 m

Contains: chimney inside diameter Ø 300 mm outside diameter 350 mm fire-resistant mineral wool 25 mm density 125 kg/m³

Insulated extension chimney 0,5m 43001312

Insulated extension chimney 1m 43001311

TUNDRA GRILL® CHIMNEY EXTENSION WITH CLOSING VALVE 1M



Material: steel

Colour: ●●

Dimensions: 1 m



Chimney Extension With Closing Valve 43001182

Chimney Extension With Closing Valve antique silver 43001169

The insulated chimneys are designed to be used in buildings in which chimneys must be fire insulated (e.g. buildings with ceilings and insulated buildings). When designing an installation, pay attention to the particular requirements applying to the building.

TUNDRA GRILL® ADDITIONAL ROOF INSULATION

Accessory for Tundra Grill insulated chimney. The additional roof insulation is intended for installation around the chimney pipe in the roof. The additional insulant comprises four different sections, each with 25 mm fire wool. Additional insulant height 500 mm. Material: stainless steel, aluminum zinc alloy and mineral fire wool



Additional roof insulation 43001313

TUNDRA GRILL® CEILING COVER PLATE

Accessory for Tundra Grill insulated chimney. Fits angles of roofs 0–30 degrees. The ceiling cover plate is used for covering the hole around the chimney made for the chimney penetration in the ceiling.



Ceiling cover plate 43001320

TUNDRA GRILL® ROOF SUPPORT

Accessory for Tundra Grill insulated chimney. The roof support is intended to support the chimney on the building roof. Tightened around the chimney. Material stainless steel.

Roof support 43001321

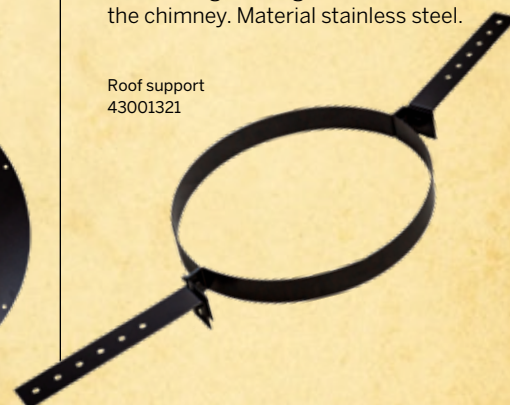

MUURIKKA™

www.muurikka.com

Opa Muurikka • Pisla Ltd.

Like us on Social Media!



Facebook:
[facebook.com/
muurikkasuomi](https://facebook.com/muurikkasuomi)



Instagram:
[muurikkasuomi](https://www.instagram.com/muurikkasuomi)



YouTube:
[Muurikka-chanel](https://www.youtube.com/channel/Muurikka-chanel)